

G R O W S P E C

LED PLANT GROW LIGHTS



TECHNOLOGY WITH RESPECT TO NATURE
© 2021 GROWSPEC



G R O W S P E C

LED Grow Light Series for Indoor Planting	2-7
LED Grow Light Series for Greenhouse Light Supplementary	8-11
Our Service of LED Grow Light Solution	12
OEM & ODM Service	13

ABOUT US

Established in 2015, GrowSpec is a biotechnology company with a 15 people R&D team for indoor and greenhouse cultivation devices development. We insist on developing the products by standing on the feet of users to truly help growers grow higher efficiently, especially for large-scale commercial indoor agriculture projects.

Since our manufacturing center in Foshan City, China set up in 2016, GrowSpec has helped many customers reached their profit targets with efficient target-oriented solutions and diversified product line. Our main products are in 3 categories:



This catalog will introduce our LED grow lights and plant lighting solutions.

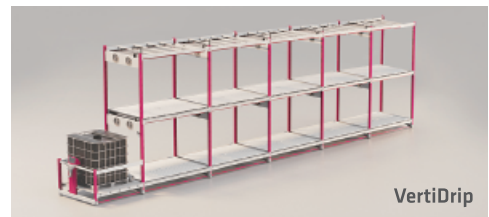

LED GROW LIGHT SERIES FOR INDOOR PLANTING

AGRISPEC Series

AgriSpec series has 6-12 light bars with 100W/bar to make 600-1,200W lamp, this lamp is designed especially for indoor artificial lighting because it should be hanging on the height of 30cm to 100cm, the light will be evenly distributed on the area covered by this lamp.

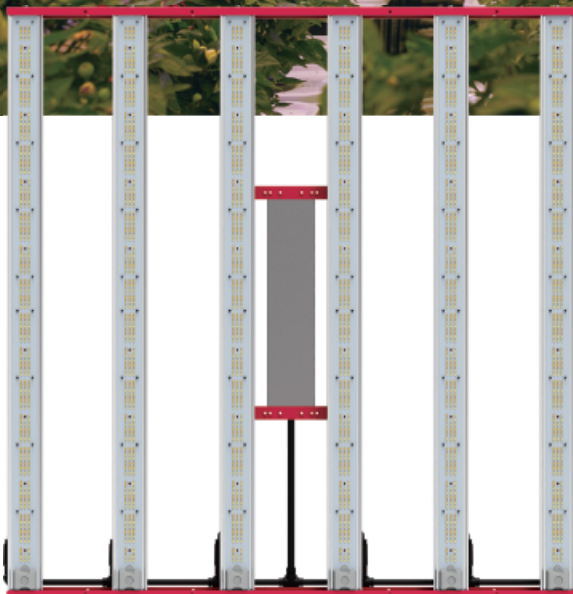

PRODUCT SPECIFICATIONS

Model	AS650	AS1000
Power	650W	1000W
PPE	2.6 $\mu\text{mol}/\text{j}$	2.6 $\mu\text{mol}/\text{j}$
PPF	1690 $\mu\text{mol}/\text{s}$	2600 $\mu\text{mol}/\text{s}$
Input Voltage	100-277V AC	100-277V AC
Cooling	Passive	Passive
Height of Hanging	8" Above	8" Above
Spectrum	Full Spectrum	Full Spectrum
Dimming	Yes	Yes
Brand	GROWSPEC or OEM	GROWSPEC or OEM
Waterproof	IP65	IP65
Warranty	5 Years	5 Years
PSU Certificates		

MEASUREMENTS

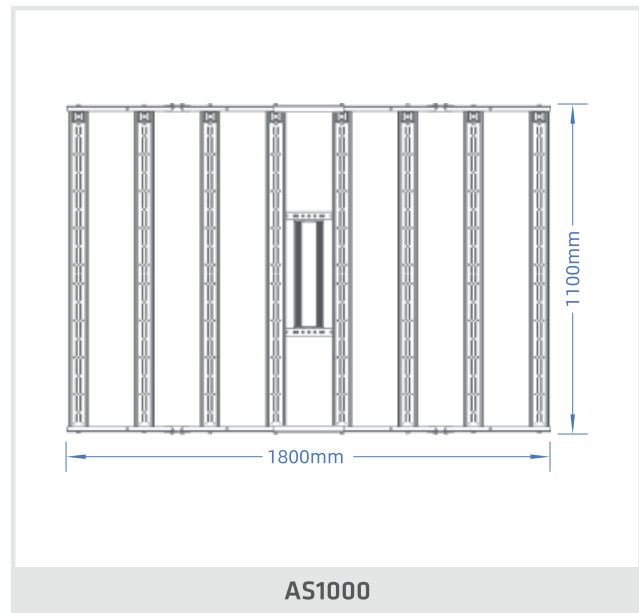
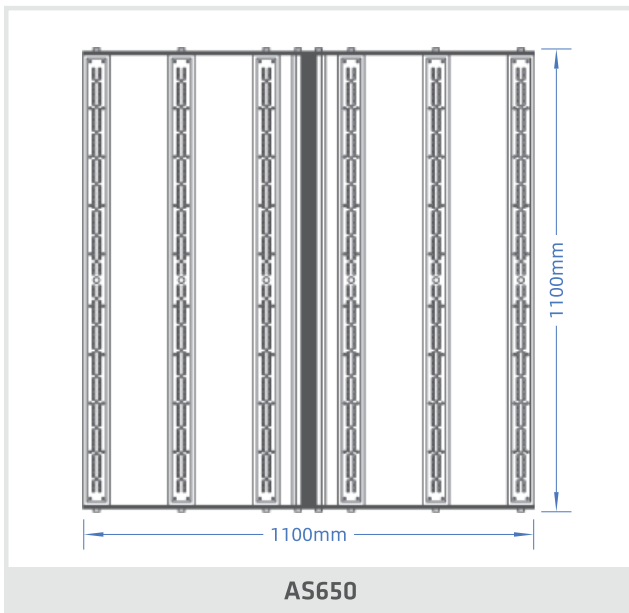

SPECTRUM FOR AGRISPEC

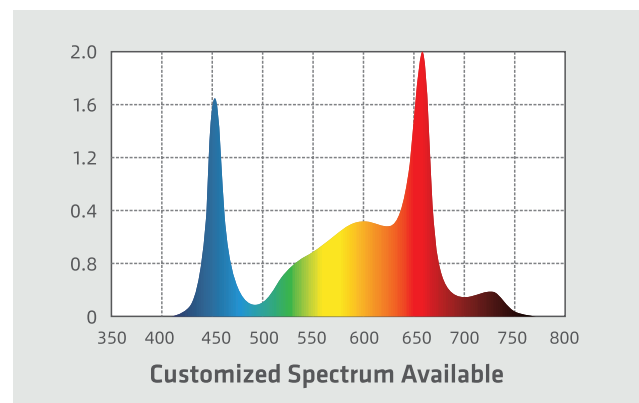
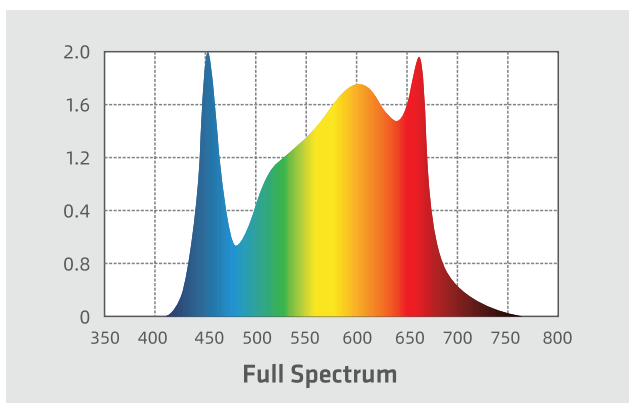



LED GROW LIGHT SERIES FOR INDOOR PLANTING

VEGBAR Series

VegBar series is designed for indoor artificial lighting for leafy greens, herbs, or clone and germination. The proper height from light to plant canopy is 15cm-60cm.



PRODUCT SPECIFICATIONS

Model	VB40	VB240	VB320	VB480
Power	40W	240W	320W	480W
PPE	2.6 $\mu\text{mol}/\text{j}$	2.6 $\mu\text{mol}/\text{j}$	2.6 $\mu\text{mol}/\text{j}$	2.6 $\mu\text{mol}/\text{j}$
PPF	104 $\mu\text{mol}/\text{s}$	624 $\mu\text{mol}/\text{s}$	832 $\mu\text{mol}/\text{s}$	1248 $\mu\text{mol}/\text{s}$
Input Voltage	24-48V AC	24-48V AC	24-48V AC	24-48V AC
Cooling	Passive	Passive	Passive	Passive
Height of Hanging	6" Above	8" Above	8" Above	8" Above
Spectrum	Full Spectrum	Full Spectrum	Full Spectrum	Full Spectrum
Dimming	Yes	Yes	Yes	Yes
Brand	GROWSPEC or OEM	GROWSPEC or OEM	GROWSPEC or OEM	GROWSPEC or OEM
Waterproof	IP65	IP65	IP65	IP65
Warranty	5 Years	5 Years	5 Years	5 Years
PSU Certificates	/			

MEASUREMENTS

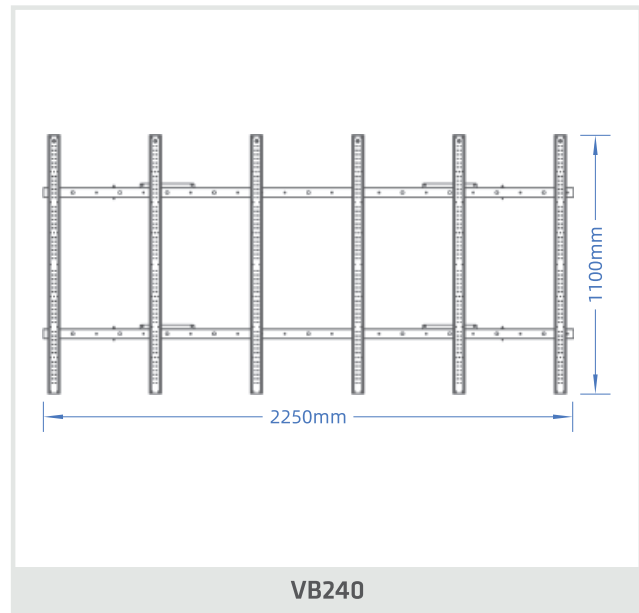
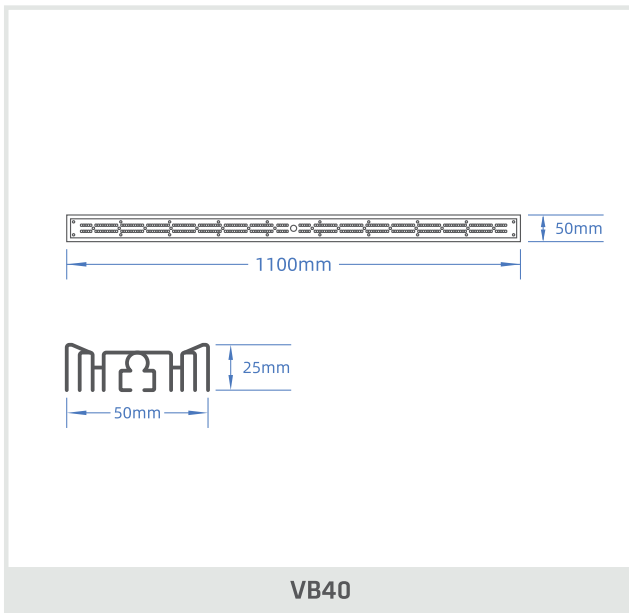

SPECTRUM FOR VEGBAR

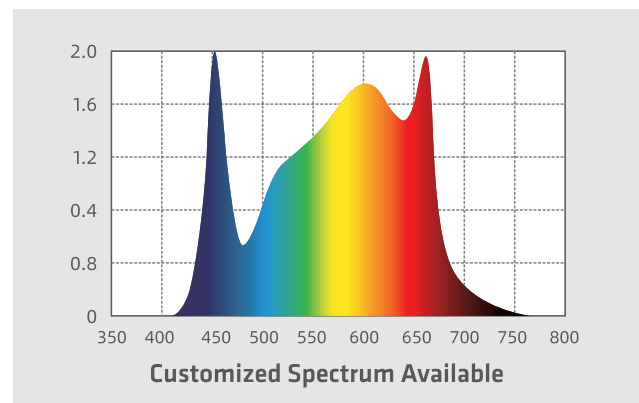
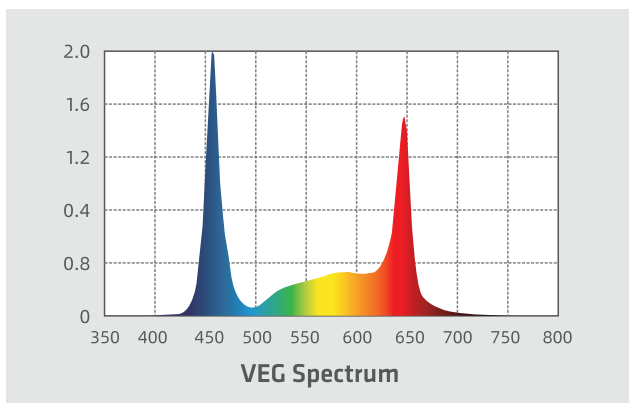

LED GROW LIGHT SERIES FOR INDOOR PLANTING

PANEL Series

PANEL lights series is good for indoor cultivation without nature lighting.

LEDs are evenly distributed on the 115cm×16cm PCB, with high PPFD at 30cm (1ft).



PRODUCT SPECIFICATIONS

Model	PN240
Power	240W
PPF	456-624 $\mu\text{mol/s}$
Efficacy	1.9-2.6 $\mu\text{mol/j}$
Input Voltage	100-277V AC
Power Factor	> 0.95@220 V
Mounting Height	20 cm-100 cm
Radiation Angle	80° / 120° / 150°
Cooling	Passively air-cooled
Original Power Cord	1 ft pigtail
Lifetime	L80: Up to 35000hrs @25°C
Warranty	5 Years
Weight Netto	16.1 lbs / 7.3 Kg
Light Color	<input checked="" type="radio"/> <input type="radio"/> <input checked="" type="radio"/> <input checked="" type="radio"/>

MEASUREMENTS

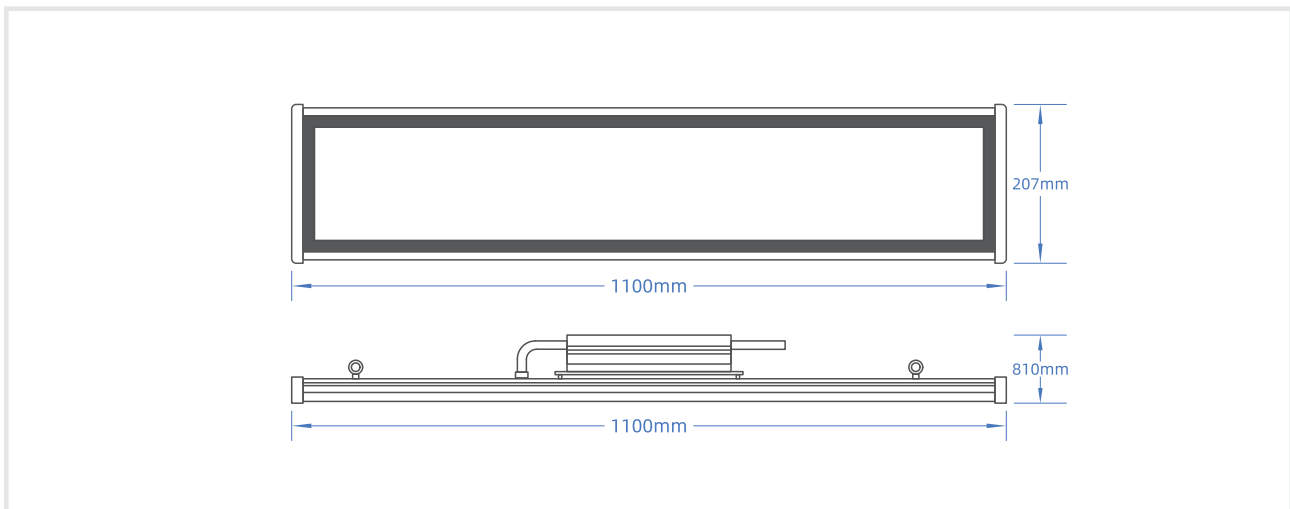

SPECTRUM FOR PANLE

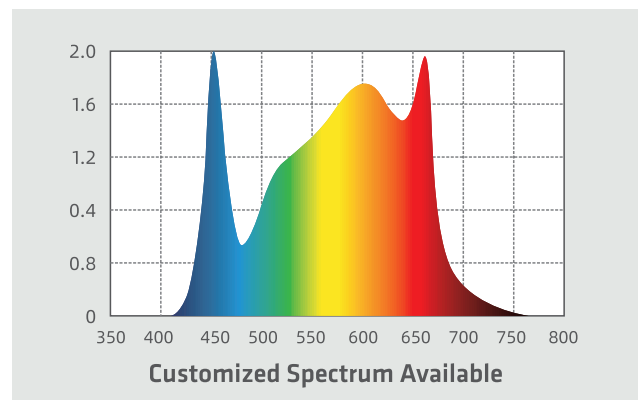
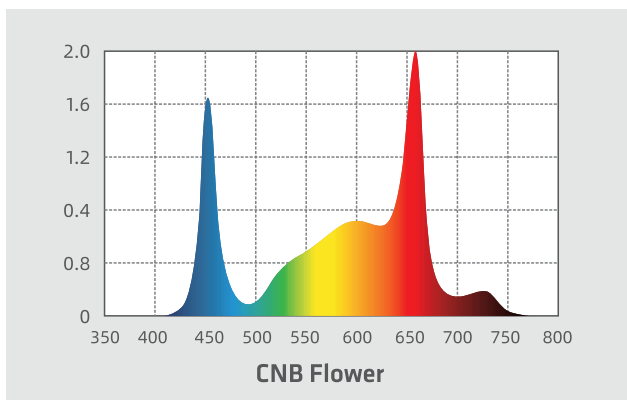

LED GROW LIGHT SERIES FOR GREENHOUSE LIGHT SUPPLEMENTARY

AGRIBAR



PRODUCT SPECIFICATIONS

Model	AB185
Power	185W
PPF	481 $\mu\text{mol/s}$
Efficacy	2.6 $\mu\text{mol/j}$
Input Voltage	100-277V AC
Power Factor	> 0.95@220 V
Mounting Height	20 cm-250 cm
Radiation Angle	30° / 60° / 80° / 120°
Cooling	Passively air-cooled
Original Power Cord	1 ft pigtail
Lifetime	L80: Up to 35000hrs @25°C
Warranty	5 Years
Weight Netto	12.8 lbs / 5.8 Kg
Light Color	● ○ ●

MEASUREMENTS

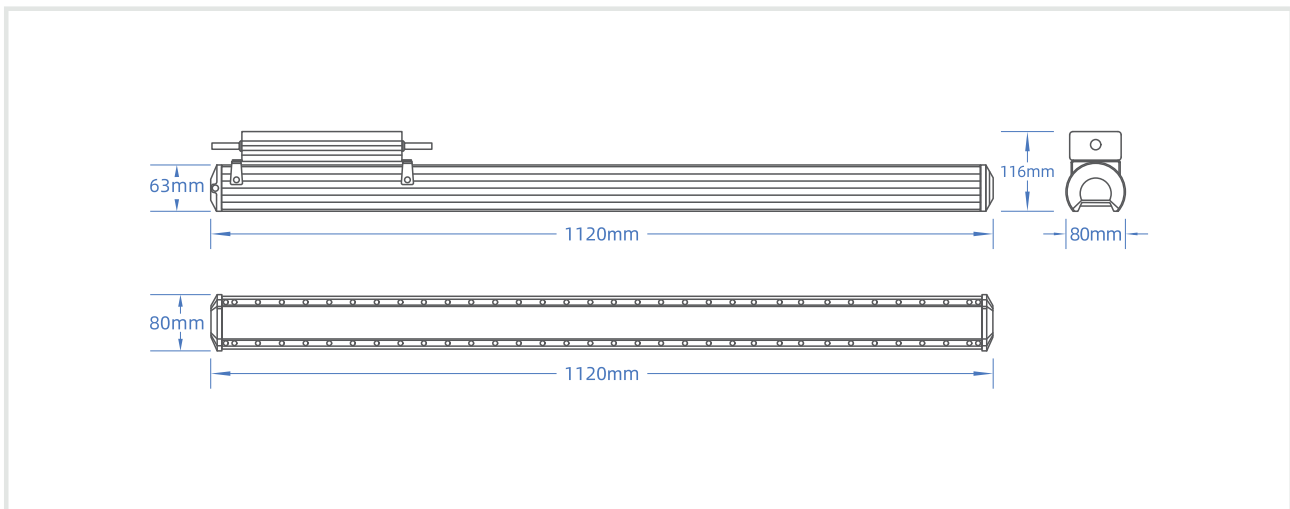

SPECTRUM FOR AGRIBAR

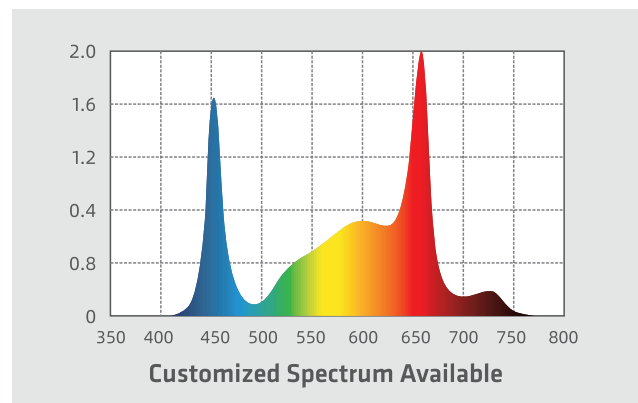
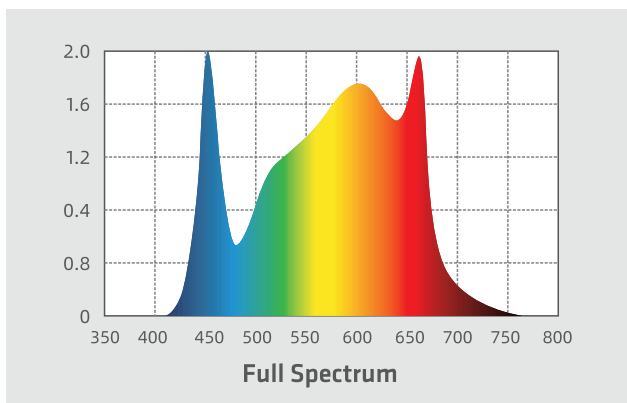

LED GROW LIGHT SERIES FOR GREENHOUSE LIGHT SUPPLEMENTARY

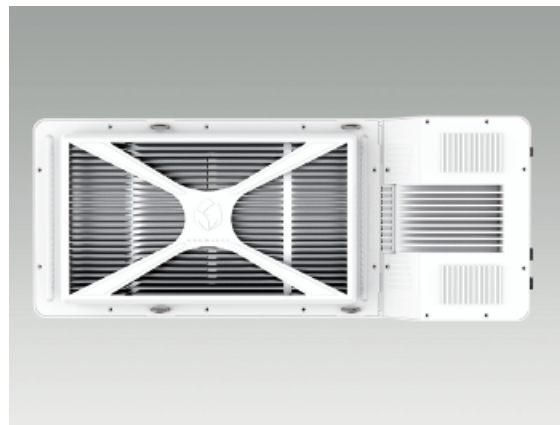
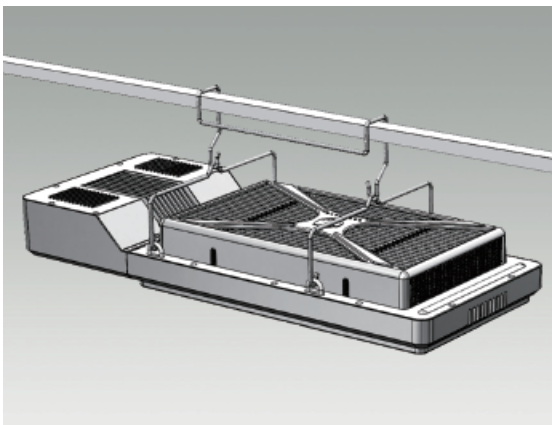

SUNRAY



NEW ARRIVAL

BEST 1 : 1 HPS 1150W REPLACEMENT

PRODUCT SPECIFICATIONS

Model	SR800
Power	800W
PPE	2.7 $\mu\text{mol}/\text{j}$
PPF	2160 $\mu\text{mol}/\text{s}$
Input Voltage	100-277V AC
Cooling	Passive
Light Source	LED
Mounting Height	Above 3'
Light Recipe	Full Spectrum
Dimmer	Power Dimming
IP	IP 66
Warranty	5 Years
Weight	39.68 lbs / 18 Kg
Certificate	   

MEASUREMENTS

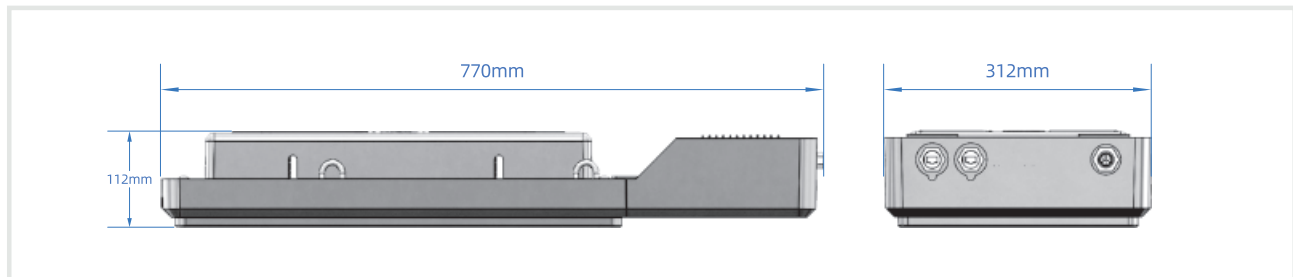

SPECTRUM FOR SUNRAY

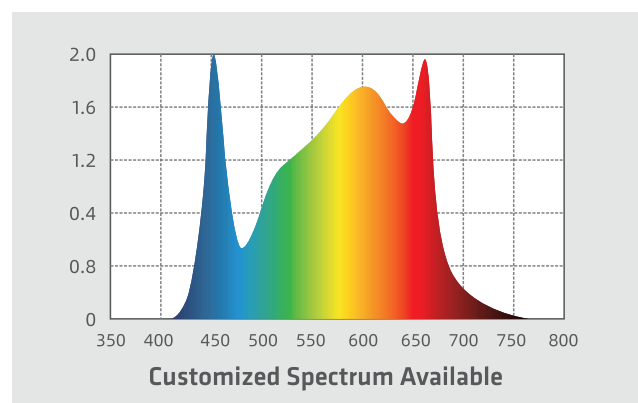
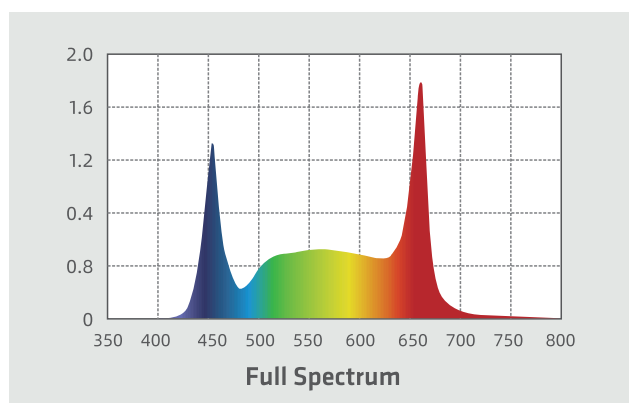

OUR SERVICE OF LED GROW LIGHT SOLUTION



When you first time contact us with a project, we will offer our suggestion on what types of LED you can choose and how many pcs you may need in how many watts. It will help you to determine how much light you need for your specific crop and growth goals. This will illustrates an optimal lighting layout for your facility to maximize light intensity and uniformity.

Our tailor-made engineering include combines the light spectrum, intensity, illumination moment, uniformity and positioning.

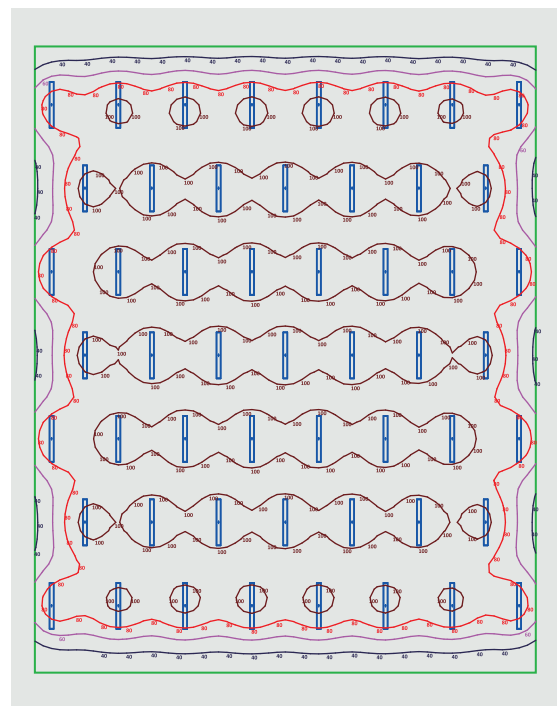
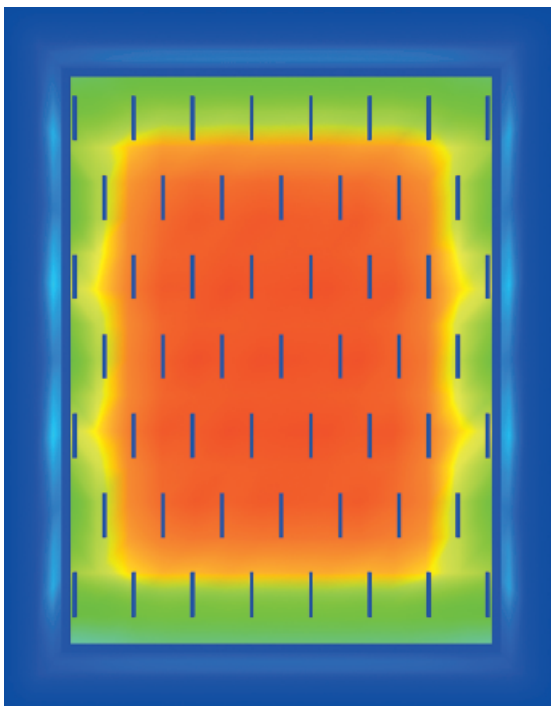

OEM & ODM SERVICE

Design

GrowSpec Can design the LED grow lights according to your requirements, including:
Power, spectrum, measurements of the grow lights.



Manufacturing

All designed products are manufactured in GrowSpec's production facility
With experienced workers.



After Service

5 years warranty
Spare parts available



- UL 1598 & CSA 22.2 No. 250.0-08:Luminaires
- UL 8750:Light Emitting Diode (LED) Equipment for Use in Lighting Products
- CSA C22.2 no. 250.13:Light Emitting Diode (LED) Equipment for Lighting Applications
- UL8800:Outline of Investigation for Horticultural Lighting Equipment
- EN 60598-1:2015.General requirements and tests
- EN 60598-2-1:1989.Particular requirements for fixed general purpose luminaires
- EN 62471:2008.Photobiological safety of lamps and lamp systems
- EN 62493:2015.Assessment of lighting equipment Related To Human Exposure To Electromagnetic Fields
- EN 55015:2013. Limits and methods of measurement of radio Disturbance characteristics of electrical lighting and similar equipment
- EN 55015:2013+A1:2015.Limits and methods of measurement of radio Disturbance characteristics of electrical lighting and similar equipment
- EN 61547:2009.Equipment for general lighting purposes-EMC immunity requirements
- EN 61000-3-2:2014. Electromagnetic compatibility(EMC) Part 3-2:Limits for harmonic current emissions(Equipment input current up to and including 16A per phase)
- EN 61000-3-3:2013.Electromagnetic Compatibility (EMC) Part 3-3: Limitation of voltage supply systems for equipment with rated current $\leq 16A$





GROWSPEC

GROWSPEC Co., Ltd.

Bldg C, Yuxin Industrial Zone, Shishan, Foshan Guangdong, China 528234

+86-757-86669696

sales@growspec-inc.com